

---

# CREATIVE TEACHING

## *Mini Report Pop-Ups*

*Color the pop-up element, cut out and attach to the folded card as shown below. Use the lines provided to write a short report on George Washington, King Tut, Ben Franklin, Noah, Hammurabi, Pyramids, Joseph, Babel, or Columbus.*

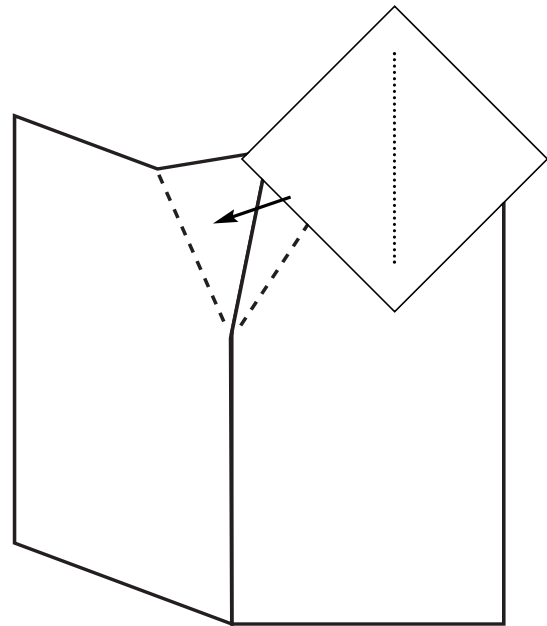
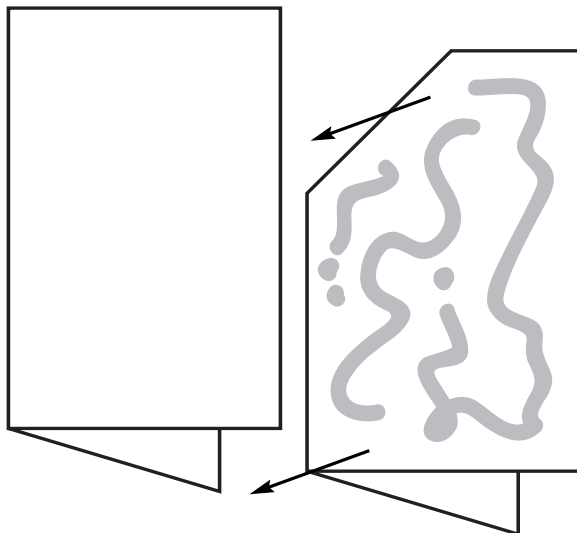
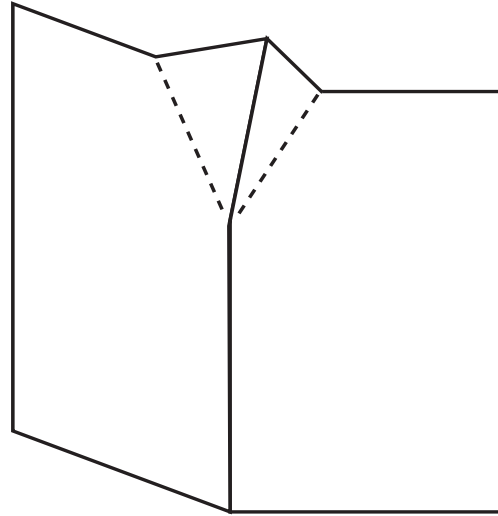
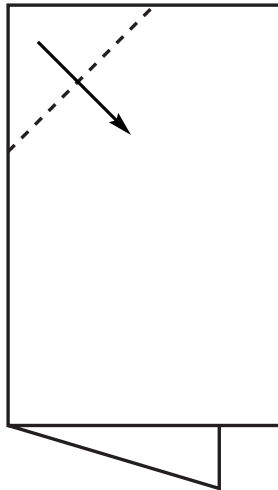

A large rectangular area with a dashed border, divided horizontally. The top and bottom halves each contain 11 vertical lines for writing. The right side is a triangle pointing left.

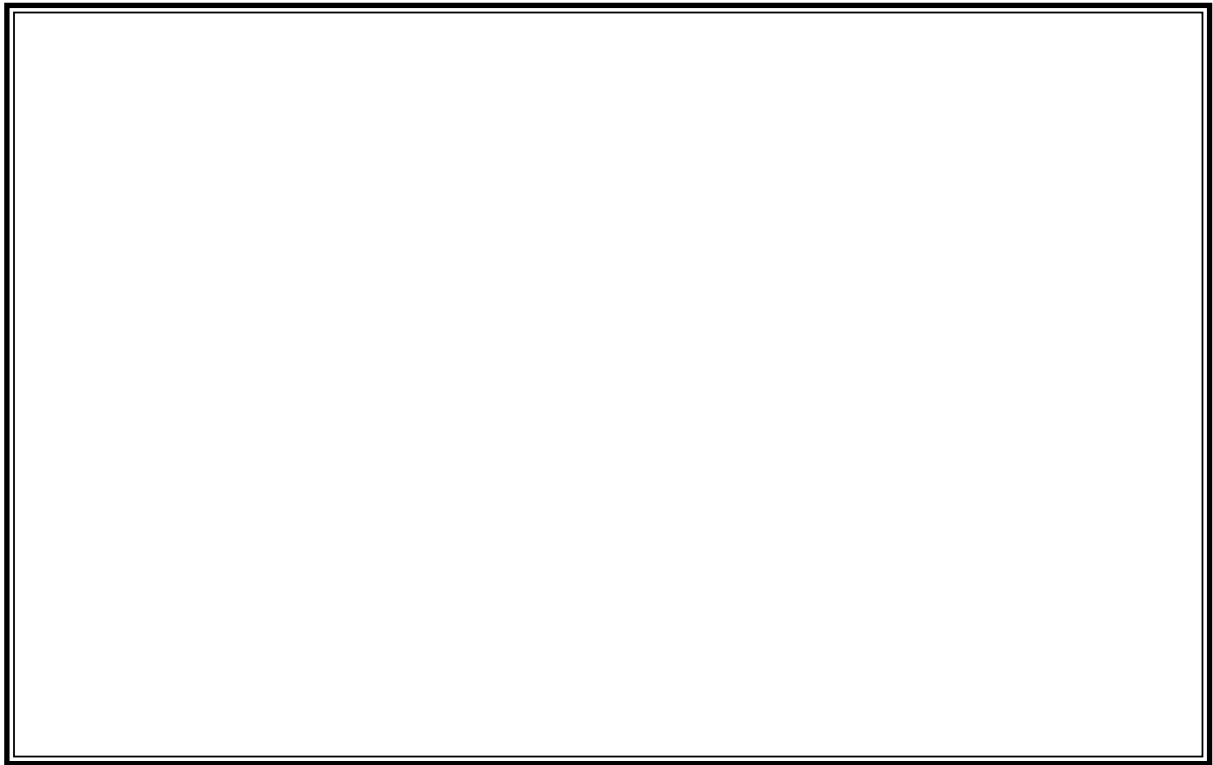
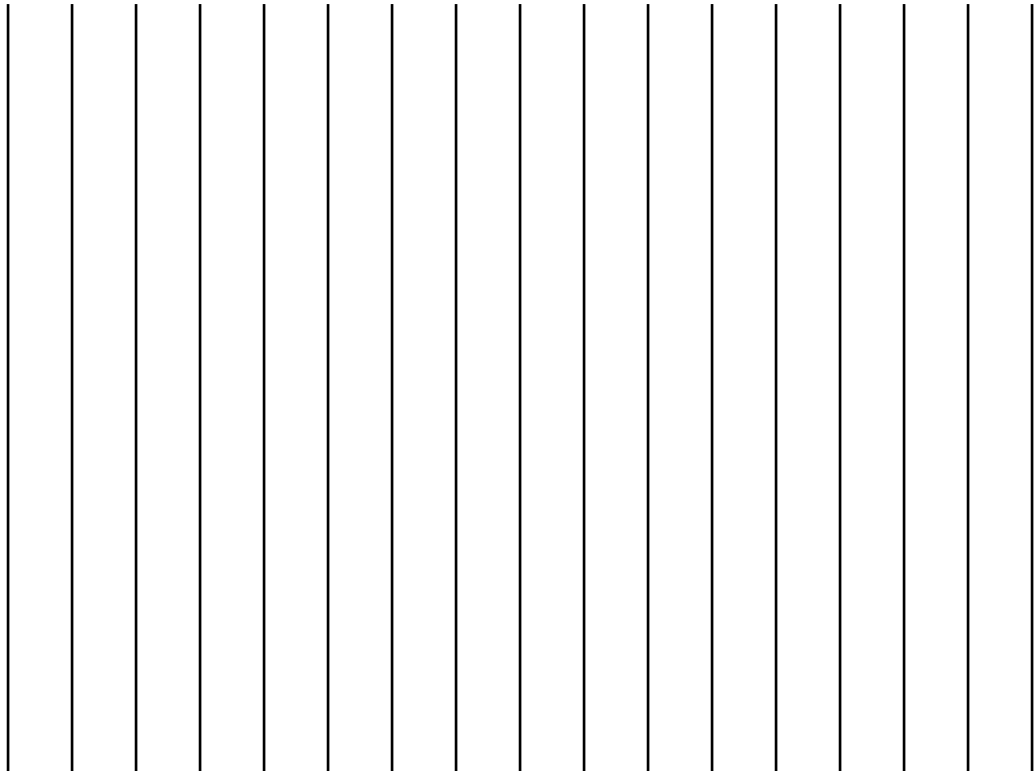

---

# CREATIVE TEACHING

## *Mini Report Pop-Ups*

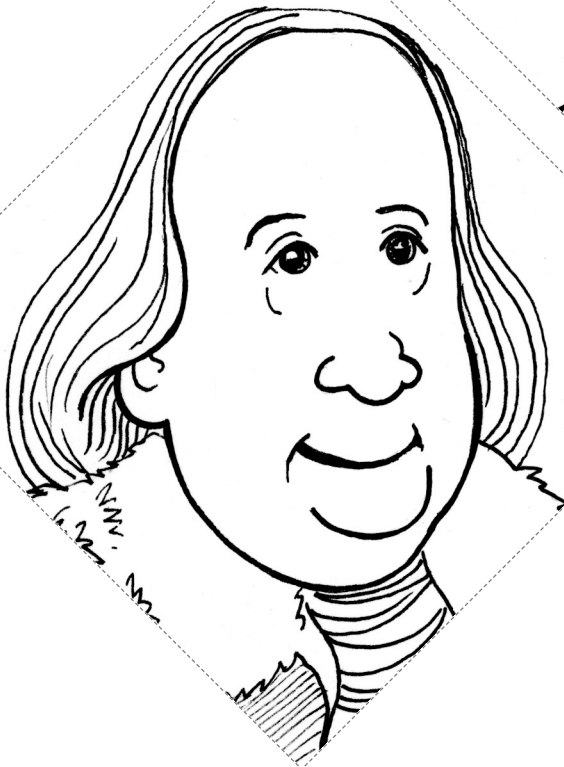
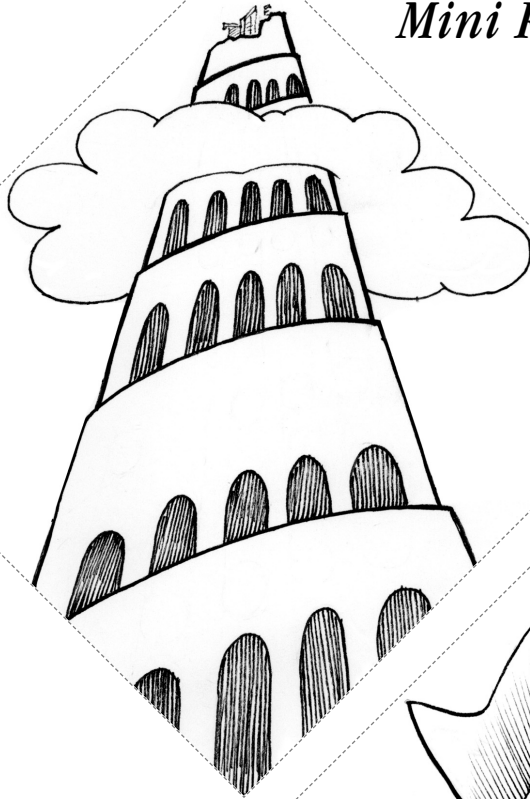

---

# CREATIVE TEACHING

*Mini Report Pop-Ups*

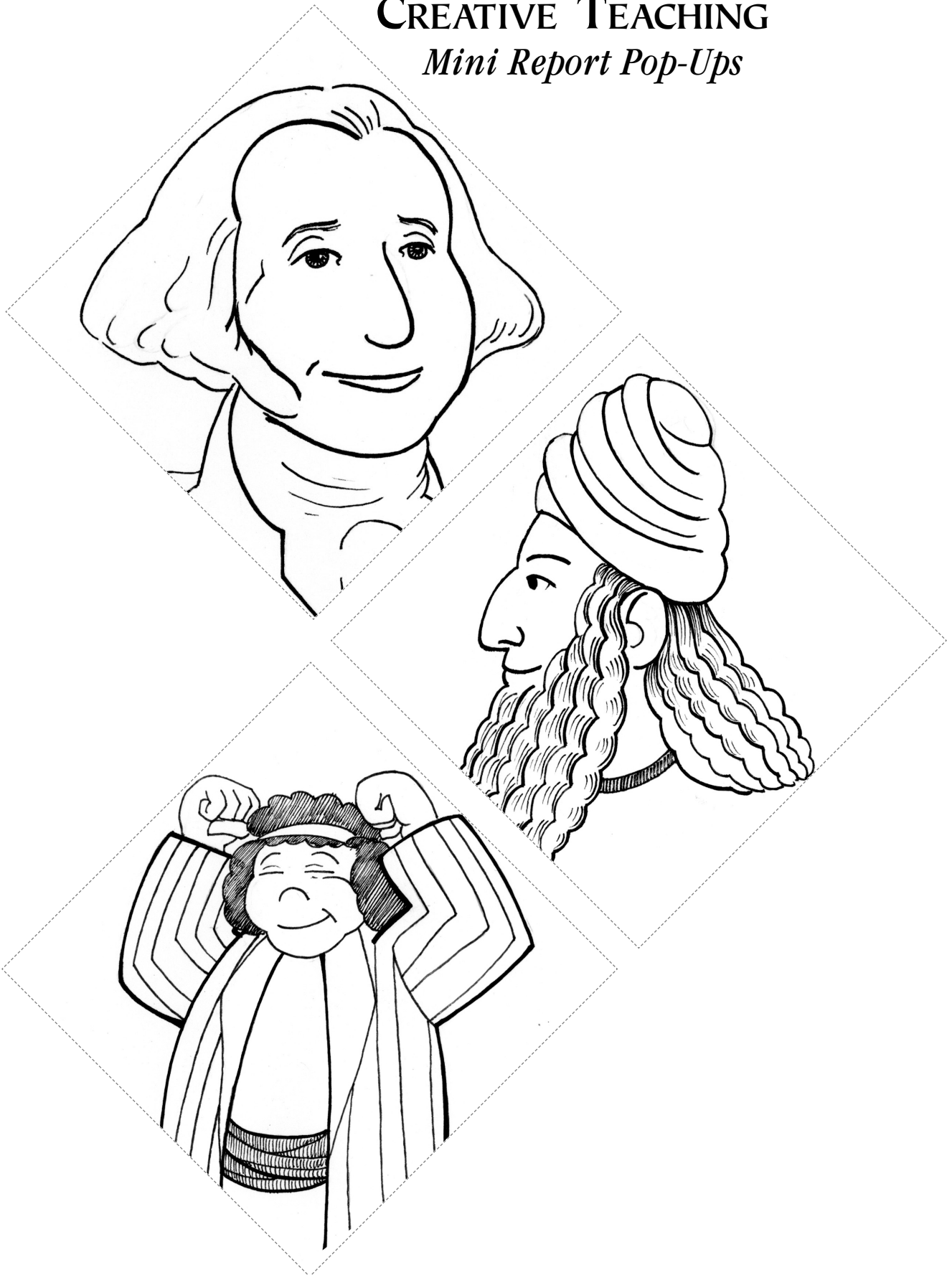

---

# CREATIVE TEACHING

*Mini Report Pop-Ups*



# CREATIVE TEACHING

## *Greek Myth Play Set*

*The following pages have paper dolls of the Greek gods, a few miscellaneous characters and a back-drop of Mount Olympus. Photocopy all the elements on card stock, color and cut out. The Mount Olympus images will overlap by half an inch.*

APHRODITE

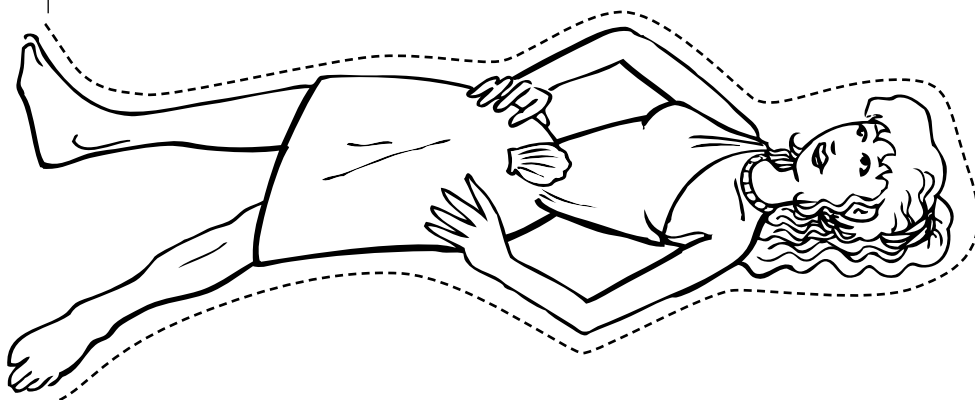

HADES

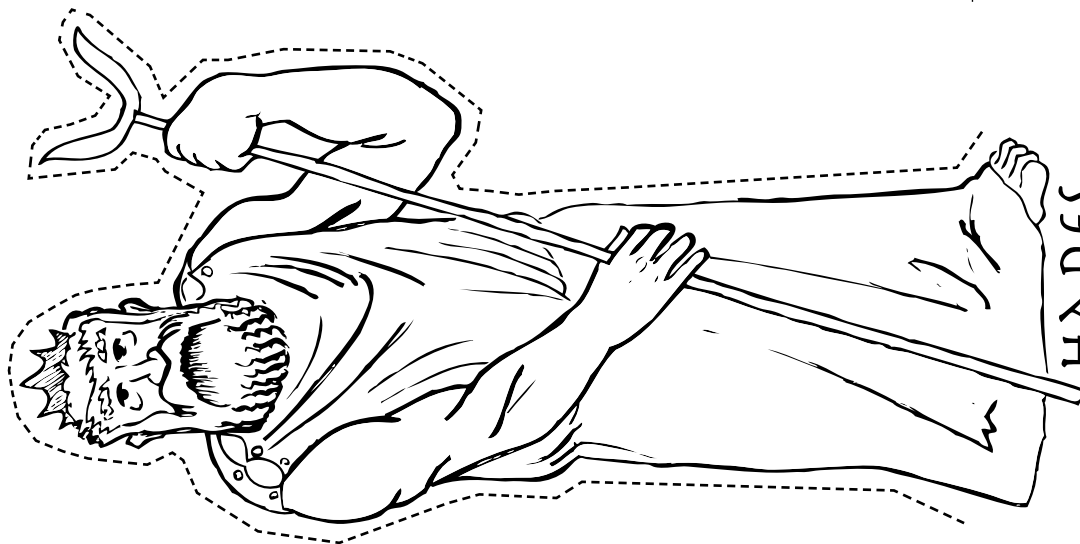





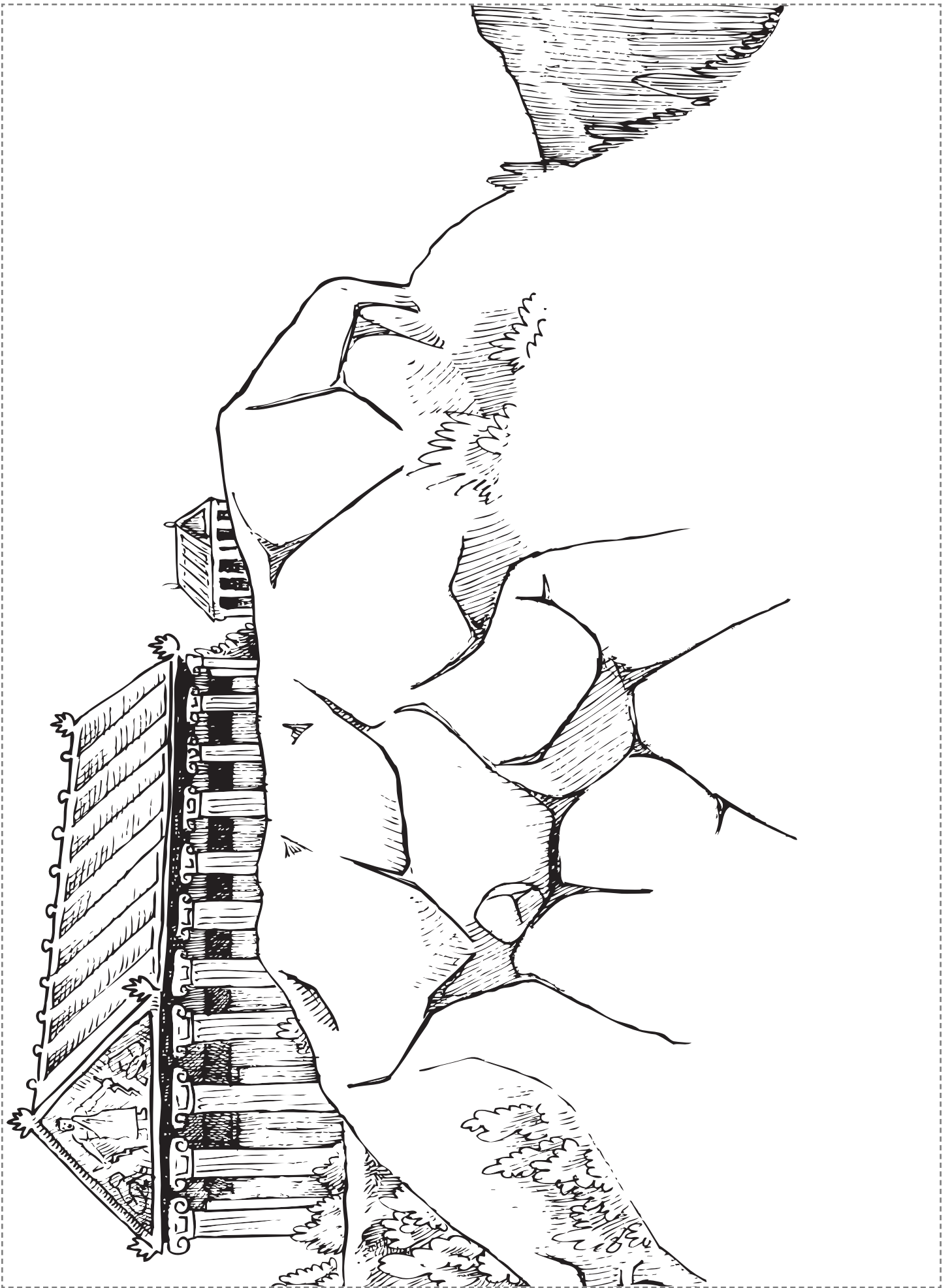

# CREATIVE TEACHING

## *Greek Myth Play Set*

HEPHAESTUS

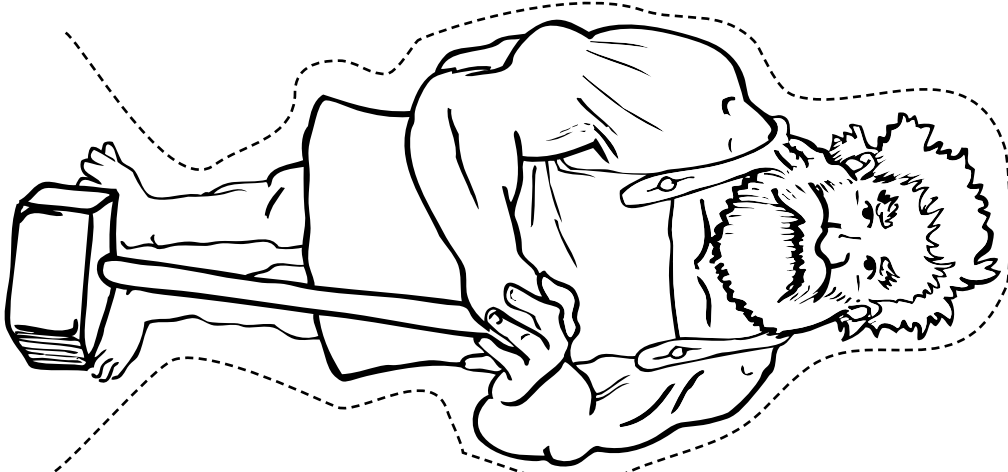

MINOTAUR

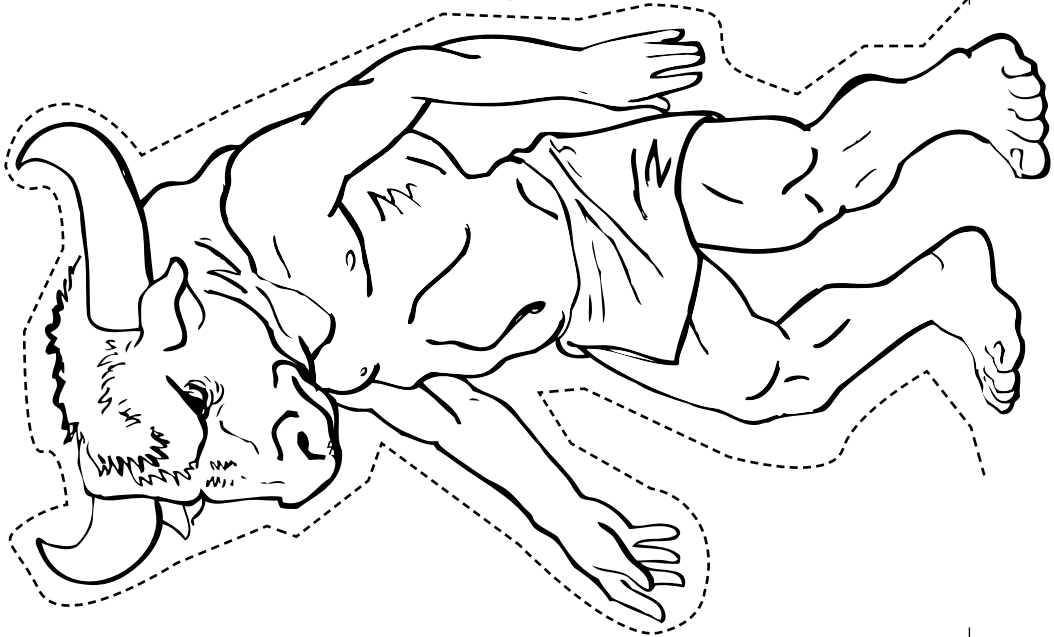

# CREATIVE TEACHING

## *Greek Myth Play Set*

HERMES

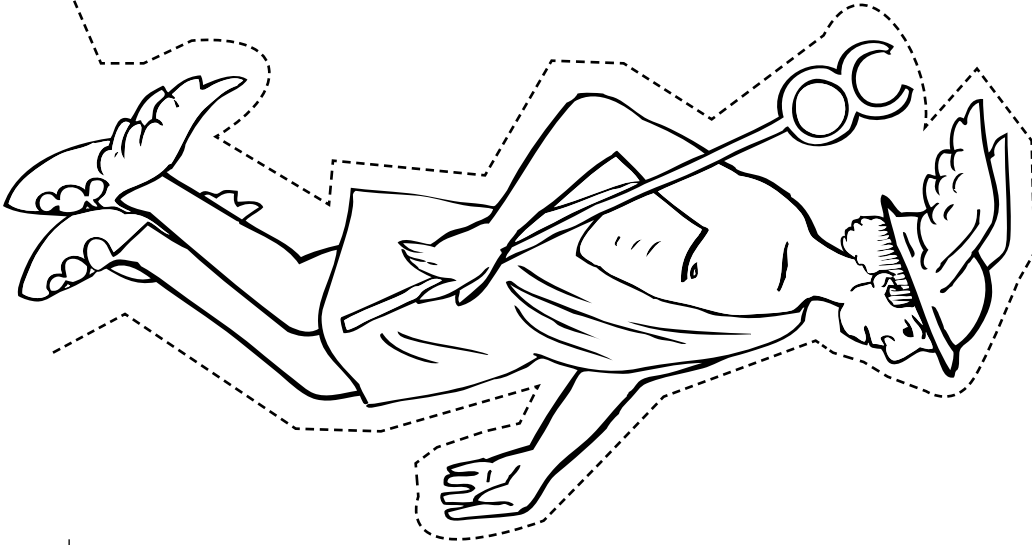

ARTEMIS

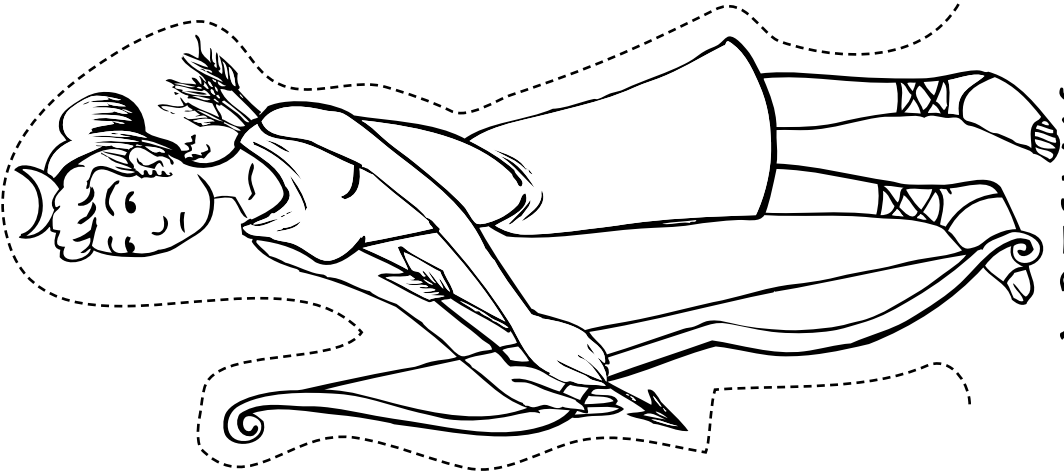

# CREATIVE TEACHING

## *Greek Myth Play Set*

DEMETER & PERSEPHONE



SATYR

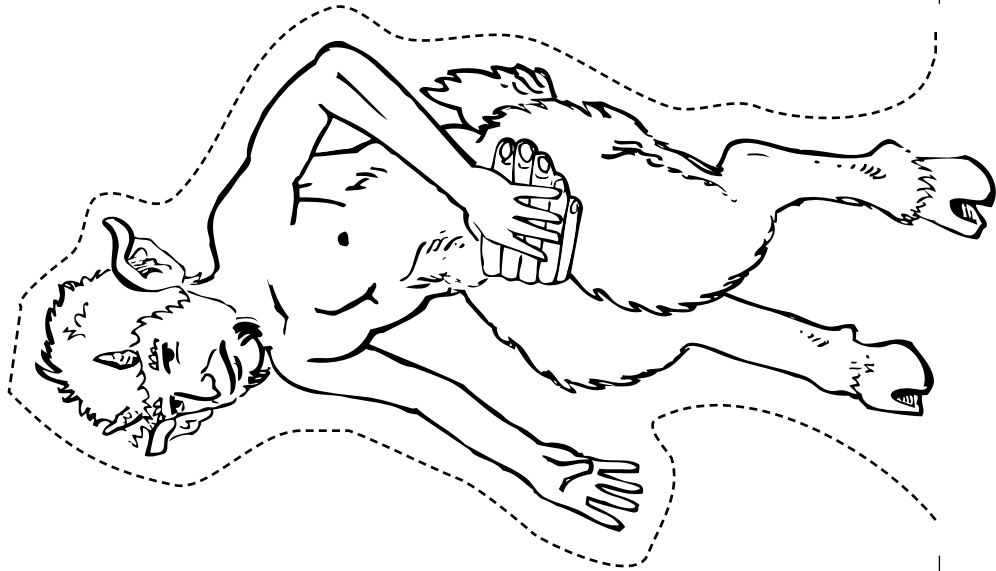

# CREATIVE TEACHING

## *Greek Myth Play Set*

CYCLOPS

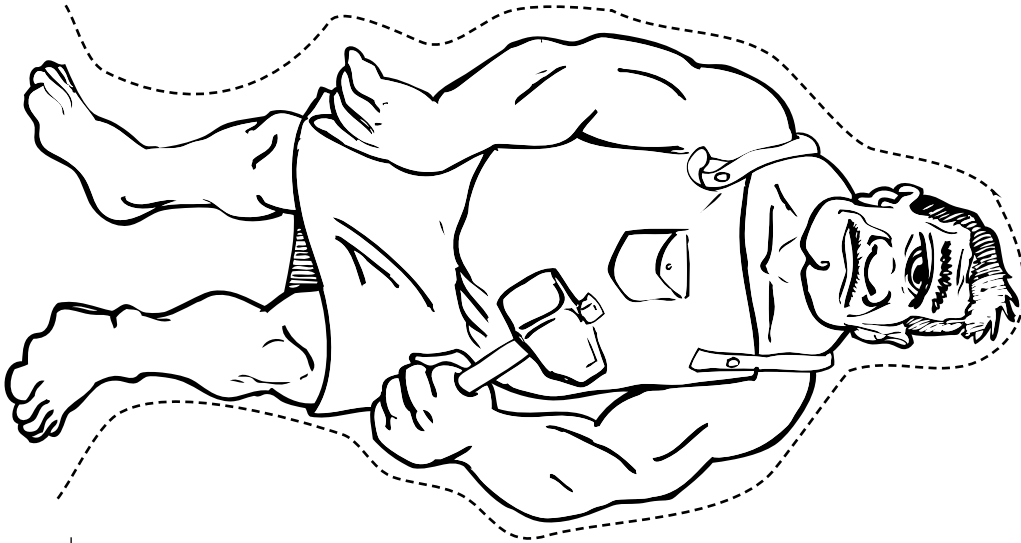

ZEUS

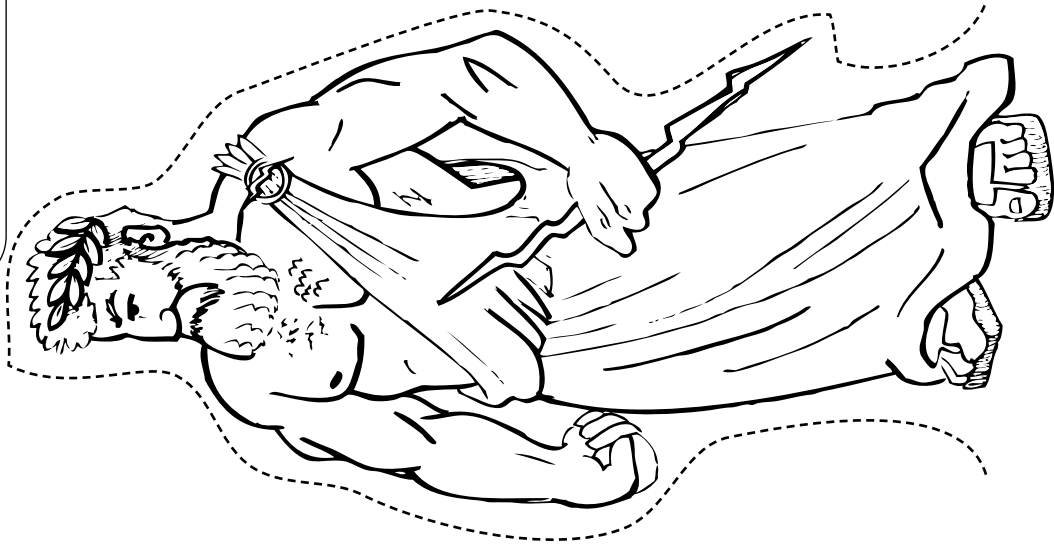

# CREATIVE TEACHING

## *Greek Myth Play Set*

HERA

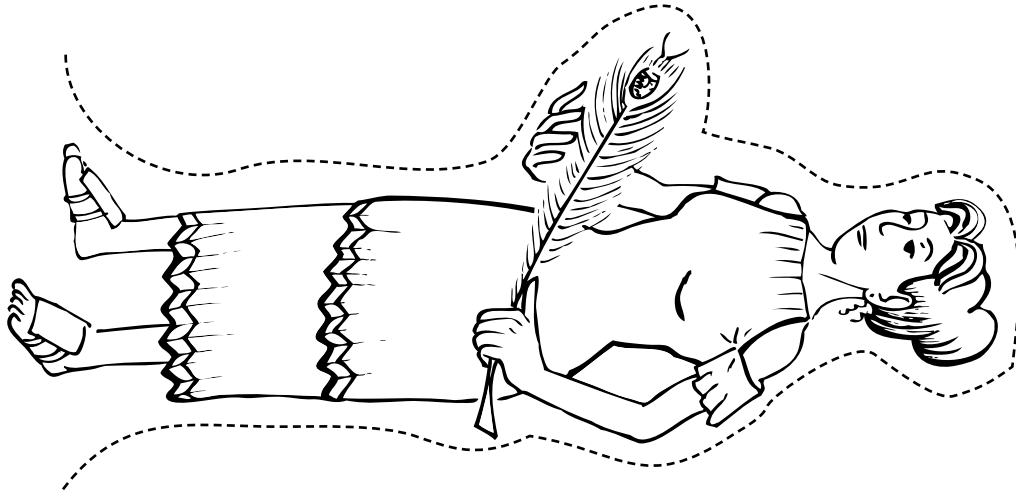

ARES

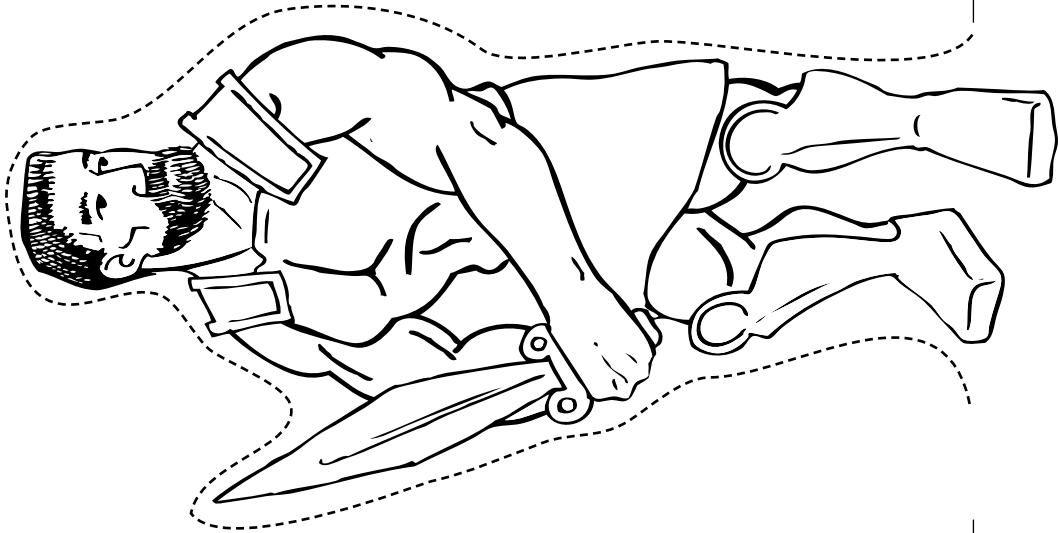

---

# CREATIVE TEACHING

## *Greek Myth Play Set*

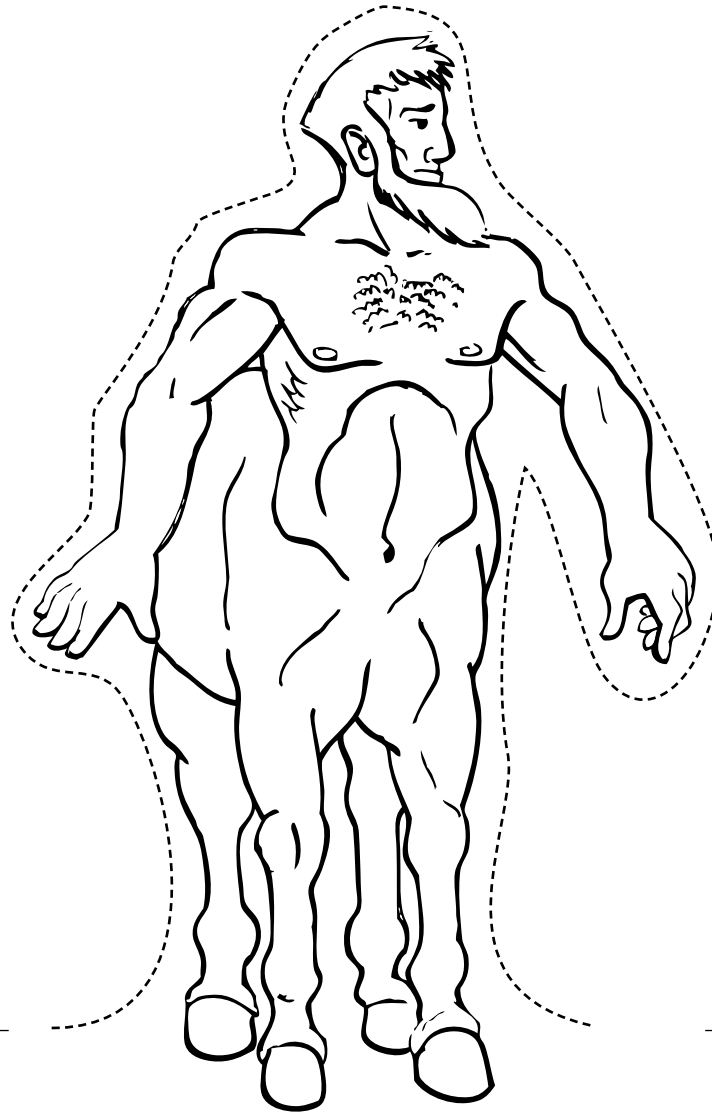

CENTAUR

---

# CREATIVE TEACHING

## *Greek Myth Play Set*

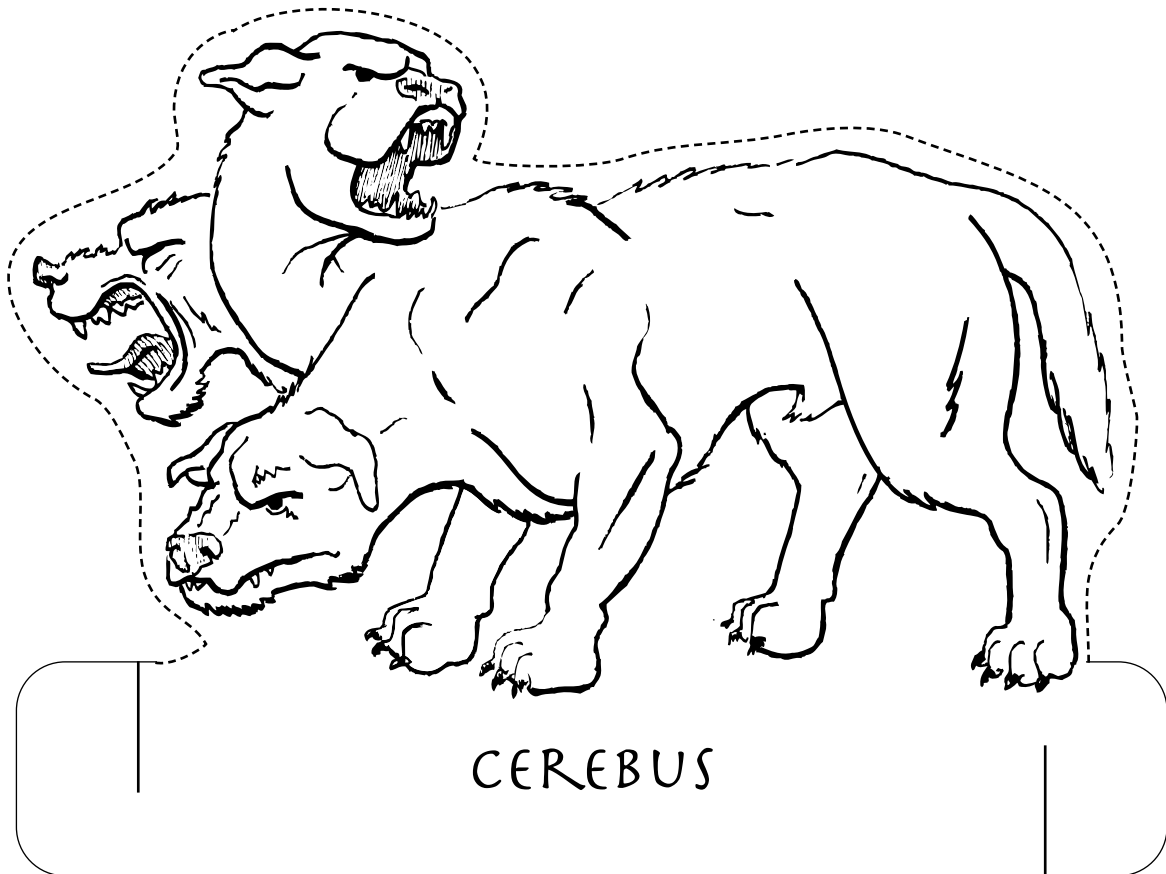



# CREATIVE TEACHING

## *Moon Mission Pop-Up Report*

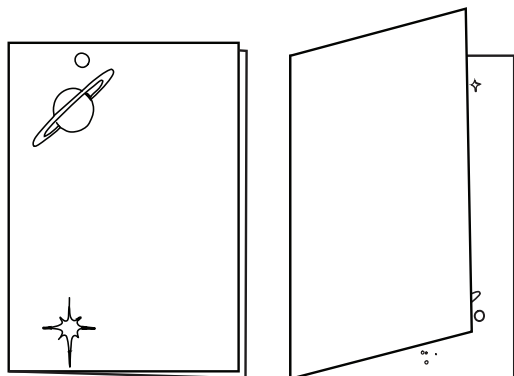

Photocopy the next three pages onto card-stock. Fold the “space” pages in half.



Color rocket. Cut out the rocket and both strips. Set rocket aside.

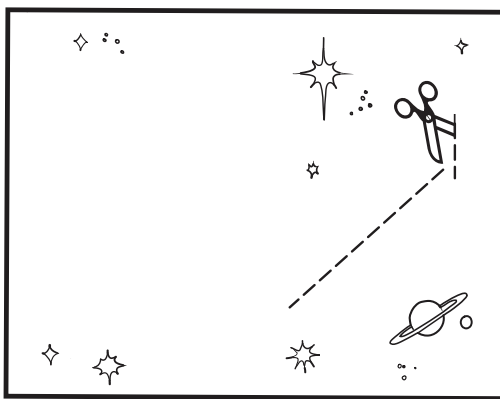

Use scissors or a cutting blade to cut the large and small slots, following the dashed lines.

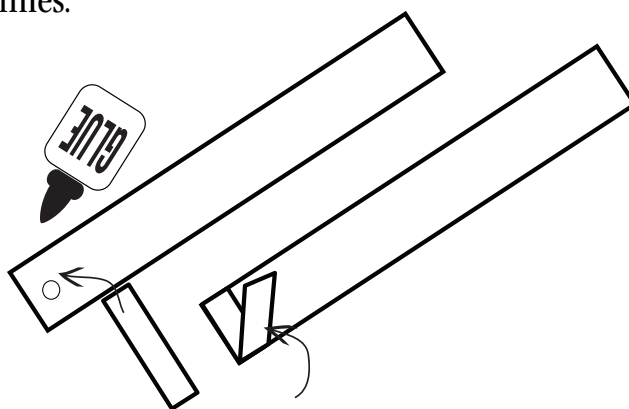

Glue the small strip to the bottom of the larger strip so that half of the smaller strip hangs over the side. Fold this half over onto itself.

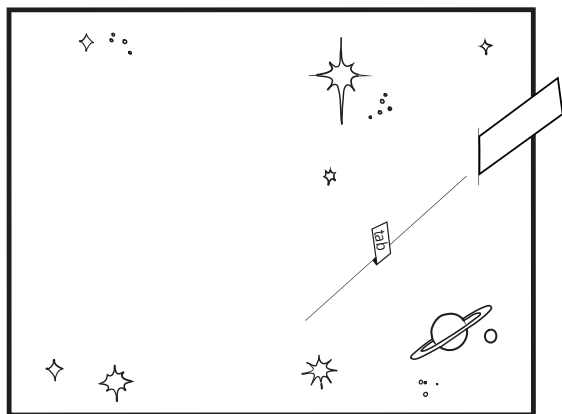

Slip the strip through the small slot. Pull the loose part of the tab through the large slot. Fold the end of the tab upwards on the tab's fold line.

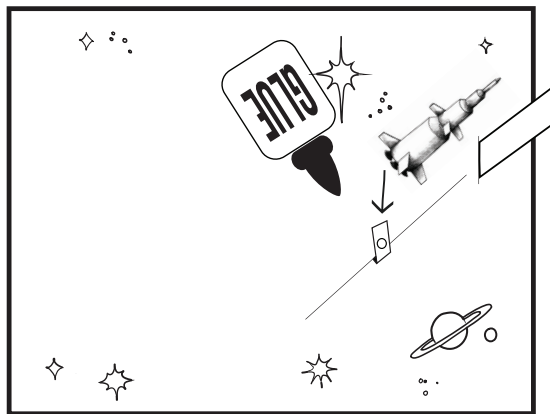

Apply a small dab of glue to the folded tab. Place the rocket on the folded tab *being sure not to glue the rocket to the card*. Allow the glue to dry before pulling on the strip.

# CREATIVE TEACHING

## *Moon Mission Pop-Up Report*

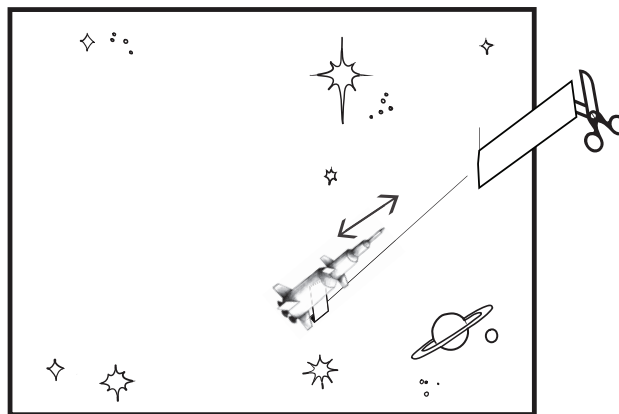

Move the rocket all the way to the bottom of the slot (closest to the fold line). Cut the end of the strip to make it shorter if necessary. The rocket should now move easily up and down the large slot of the card.

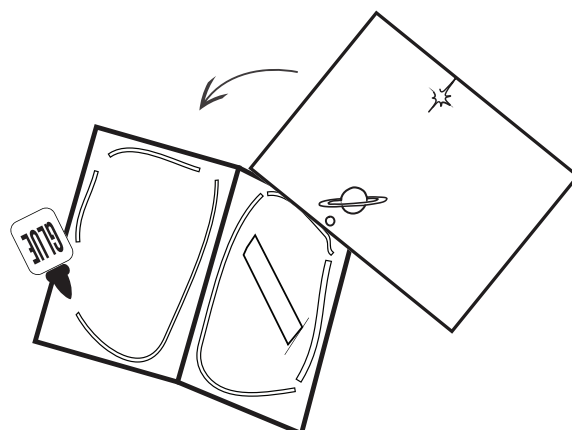

Turn the card over and carefully apply glue around the edges of the back of the card away from the slots. *Make sure that you do not apply glue to the slots, the strip or the rocket.* Place cover on top of the rocket card. Press firmly.

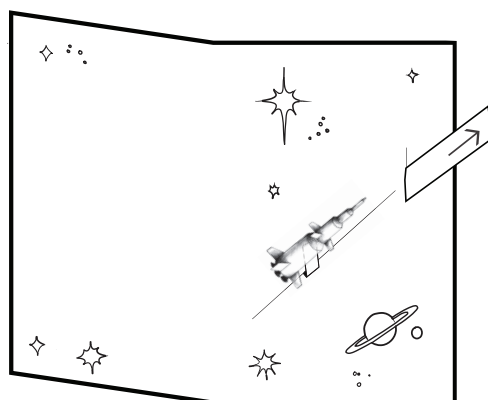

Write a report on the lined pages about one of the moon missions. Decorate the front and inside of your card.

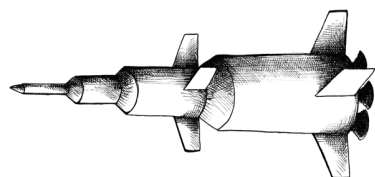

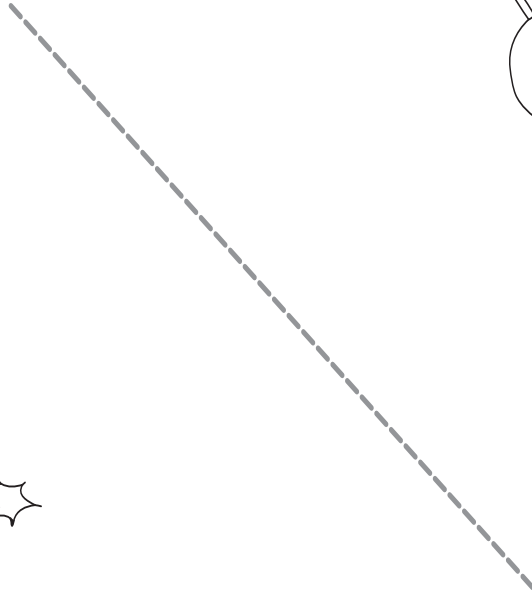
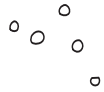
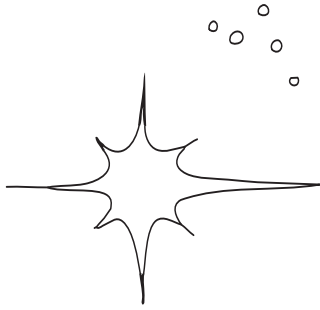
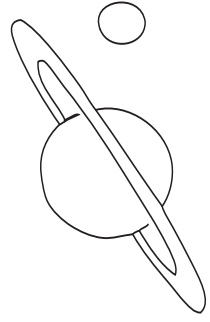

A series of 18 vertical parallel lines spanning the width of the page, intended for handwriting practice.

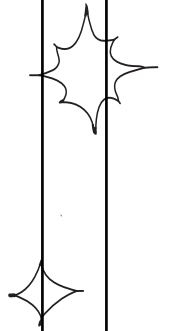
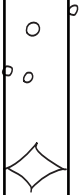

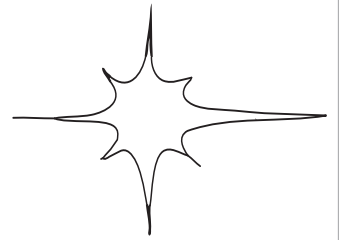
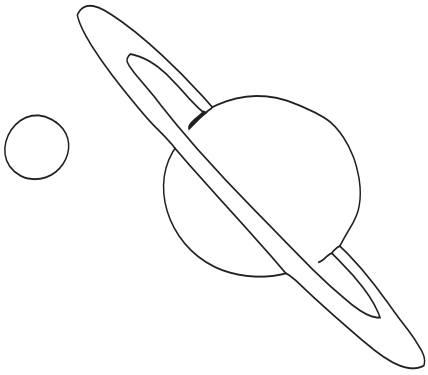

A series of 20 vertical lines, evenly spaced, extending from the top of the lower section to the bottom of the page, serving as a writing guide.

# CREATIVE TEACHING

## *Inventions Pop-Up Report*

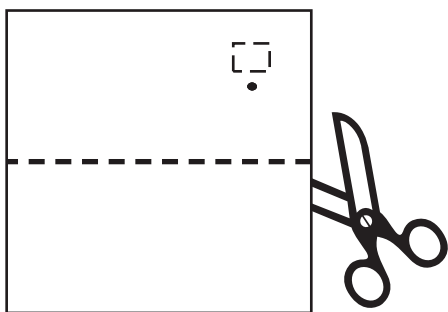

Photocopy the following two pages onto cardstock. Cut along dashed lines on the first page and fold each half in half again.

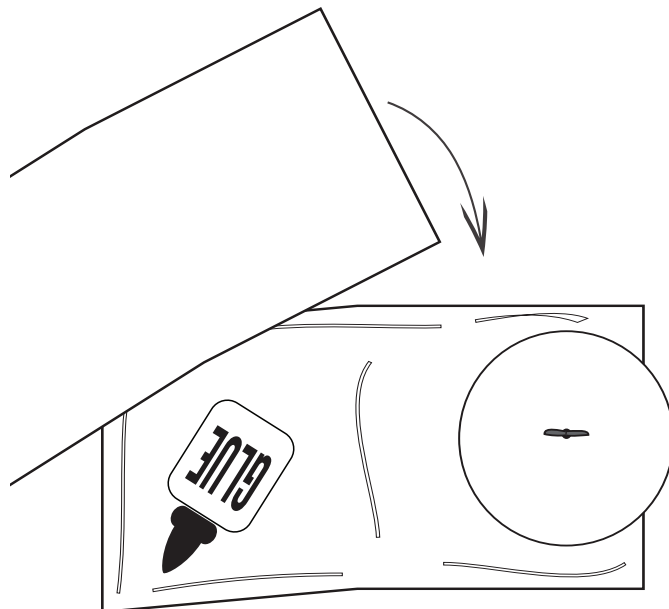

Turn the card over. Apply glue around the edge of the paper, away from the circle area. Carefully put the other card on top of the glued card. Press firmly. When you turn the circle, an invention should show through the window.

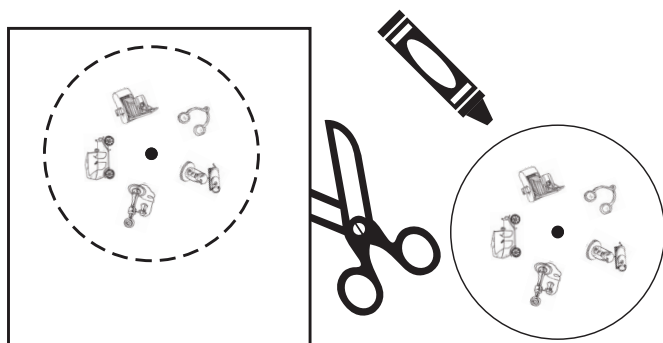

Cut out the inventions wheel and color.

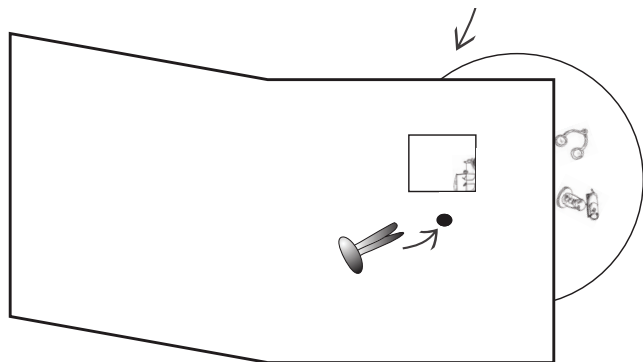

Place the circle under the card with the window. Line up the small black circles on both the card and inventions wheel. Take a paper fastener and push it through the circle on the card and then on the wheel. Close the fastener.

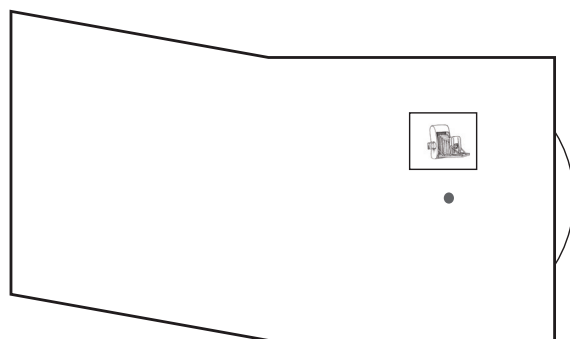

Decorate the front (perhaps with the title "Amazing Inventions!") and write up a brief report on the invention of the automobile, telephone, eyeglasses, telescope, and camera on the inside of the card.

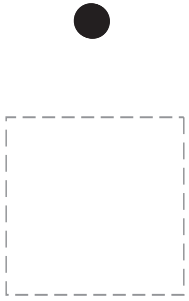
---

# CREATIVE TEACHING

*Inventions Pop-Up Report*

